



STERIPIG: sistema para la recuperación de producto restante dentro de una tubería.

STERIPIG: system for the recovery of any product remaining in the pipeline.

Accesorios BPE
BPE fittings

PIEZAS ESPECIALES CUSTOMIZED PIECES

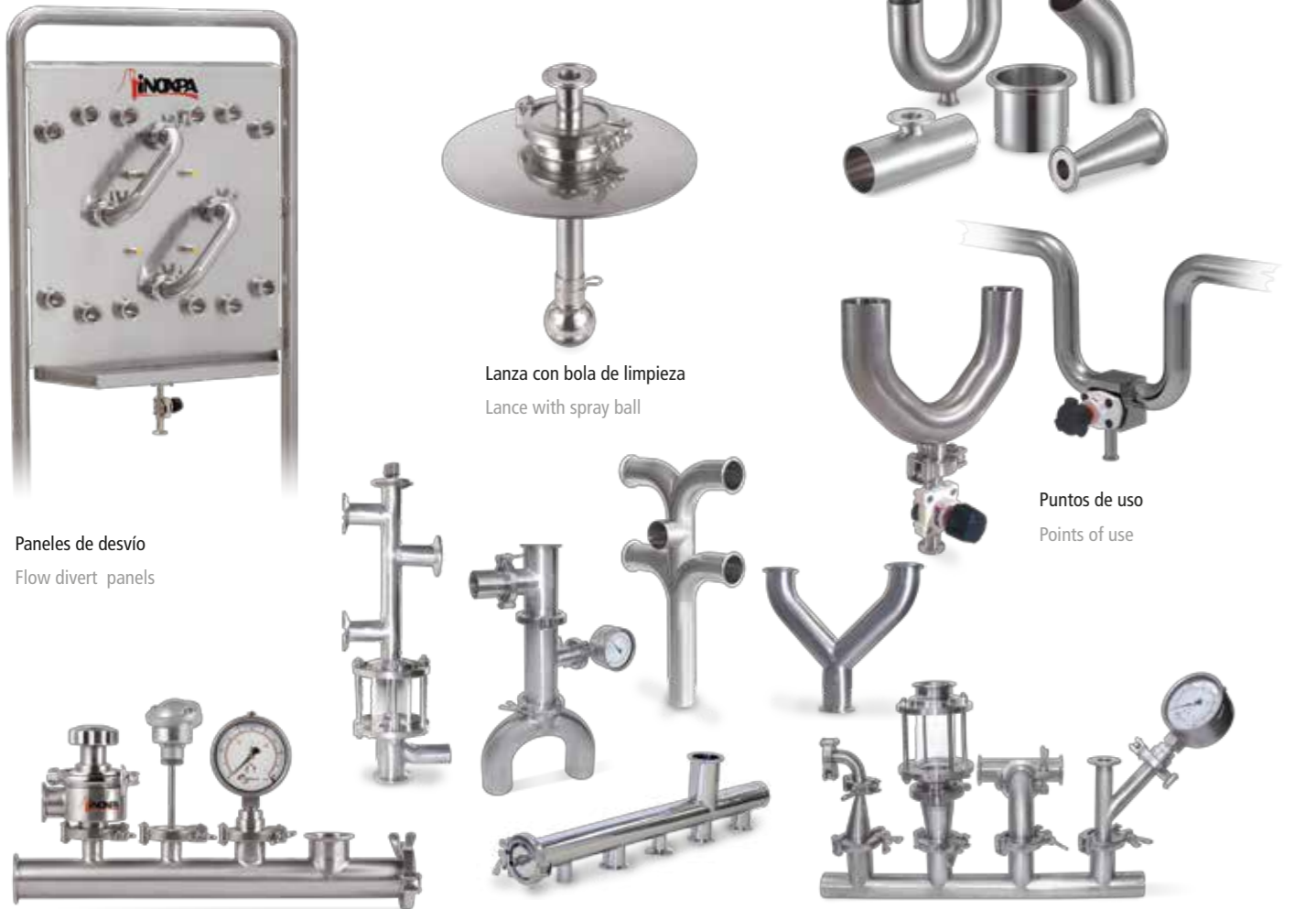

Lanza con bola de limpieza
Lance with spray ball

Puntos de uso
Points of use

Paneles de desvío
Flow divert panels

Colectores y piezas especiales
Collectors and customized pieces



INOXPA SA
Telers, 54 – PO Box 174 – 17820
BANYOLES (Girona – Spain)
Tel. +34 972 57 52 00
Fax +34 972 57 55 02
GSM +34 667 16 85 20
inoxpa@inoxpa.com

www.inoxpa.com

DELEGACIÓN NORDESTE
BARCELONA
Tel. +34 937 297 280
inoxpa.nordeste@inoxpa.com

DELEGACIÓN CENTRO
MADRID
Tel. +34 918 716 084
inoxpa.centro@inoxpa.com

DELEGACIÓN LEVANTE
VALENCIA
Tel. +34 963 170 101
inoxpa.levante@inoxpa.com

DELEGACIÓN SUR
CADIZ
Tel. +34 956 140 193
inoxpa.lsur@inoxpa.com

SUMINISTROS TÉCNICOS ALIMENTARIOS, S.L.
VIZCAYA
Tel. +34 944 572 058
sta@inoxpa.com

DELEGACIÓN VALLADOLID
Tel. +34 983 403 197
sta.valladolid@inoxpa.com

DELEGACIÓN GALICIA, ASTURIAS Y LEÓN
Tel. +34 638 334 359
sta@inoxpa.com

INOXPA SOLUTIONS FRANCE, SARL
LYON
Tel. +33 474627100
inoxpa.fr@inoxpa.com

PARIS
Tel. +33 130289100
isf@inoxpa.com

S.T.A. PORTUGUESA LDA
ALGERIZ
Tel. +351 256472722
comercial.pt@inoxpa.com

IMPROVED SOLUTIONS PORTUGAL LDA
VALE DE CAMBRA
Tel. +351 256 472 138
isp.pt@inoxpa.com

INOXPA SKANDINAVIEN A/S
DENMARK
Tel. +45 76286900
inoxpa.dk@inoxpa.com

INOXPA ITALIA, S.R.L.
VENEZIA
Tel. +39 041 - 411236
inoxpa.it@inoxpa.com

INOXPA UK LTD
KENT
Tel. 01737 378060
inoxpa-uk@inoxpa.com

INOXRUS
SAINT PETERSBURG
Tel. +7 812 622 16 26
spb@inoxpa.com

MOSCOW
Tel. Fax +7 495 6606020
moscow@inoxpa.com

INOXRUS UKRAINE
KIEV
Tel. +38044 536 09 57
kiev@inoxpa.com

INOXPA COLOMBIA SAS
BOGOTÁ
Tel. 57-1-7427577
inoxpa.colombia@inoxpa.com

INOXPA USA, INC
CALIFORNIA
Tel. +1 707 585 3900
inoxpa.us@inoxpa.com

INOXPA AUSTRALIA PTY LTD
MORNINGTON
Tel. +61 (3) 5976 8881
inoxpa.au@inoxpa.com

INOXPA SOUTH AFRICA GAUTENG
Tel. +27 (0)11 794-5223
sales@inoxpa.com

INOXPA ALGERIE S.A.R.L.
ALGER
Tel. +213 (0) 23 83 02 57
inoxpalgerie@inoxpa.com

INOXPA SPECIAL PROCESSING EQUIPMENT (JIAXING), CO., LTD.
JIAXING, CHINA
Tel. 00 86 573 83570035
inoxpa.cn@inoxpa.com

INOXPA INDIA PRIVATE LIMITED
MAHARASHTRA
Tel. +91 020-64705492
inoxpa.in@inoxpa.com

INOXPA MIDDLE EAST DUBAI, UAE
Tel. +971 (0)4 372 4408
sales.ae@inoxpa.com



FARMACIA Y COSMÉTICA PHARMACY AND COSMETICS

Diposit legal: GI.581-2007. Fotos no contractuales. Photos are not binding.



“Mi compromiso personal y el de todo el equipo de INOXPA es ofrecer el mejor servicio posible y las soluciones más ajustadas a las necesidades de los clientes”.
Candi Granés, General Manager.

FABRICANTES CON ESPÍRITU DE SERVICIO

En INOXPA tenemos claro, que todos los elementos y en general todo lo que significa desarrollo tecnológico, no es sino un medio para ofrecer el mejor servicio a nuestros clientes. Partimos del concepto compromiso: usted desea una tecnología útil y eficaz que le resuelva sus necesidades con garantía y seguridad, y este es nuestro reto. Partimos de excelentes materias primas, acabados y sistemas homologados y certificados con tecnologías probadas, dignas de la mayor de las solvencias. Nuestro horizonte sigue siendo ofrecer soluciones a través del servicio y la adaptación de cada producto al proceso productivo de nuestros clientes. Esta voluntad de adaptación y servicio la hallará detrás de una marca que aspira a ser un socio sólido y fiable para su empresa.



DIVISIÓN FARMACÉUTICA (ISF)

Inoxpa dispone de una división especializada en la fabricación de componentes y equipos para la industria farmacéutica, con profesionales experimentados en el sector y preparados para cumplir los más estrictos requisitos requeridos en la industria farmacéutica. Además se dispone de unas instalaciones preparadas para la fabricación de estos componentes y equipos, con los correspondientes equipos de control y pruebas.

“My personal commitment and that of the entire INOXPA team is to offer the finest possible service and the solutions best suited to your needs.”.
Candi Granés, General Manager.

MANUFACTURERS WITH A SPIRIT OF SERVICE

We at INOXPA are convinced that all our products and everything involved in the technological development in general is simply means towards offering our clients the finest service. We start out from a concept of commitment: you want useful and effective technology which securely guarantees that your needs are resolved, and that is our challenge. We take as our starting point excellent raw materials with officially approved and certified finishes and systems and proven technologies worthy of the utmost confidence. Our horizon remains that of continuing to offer solutions through service and by adapting each product to our clients' productive processes. You will find this determination to adapt and provide service behind a trademark that aspires to be a firm and reliable partner of your company.

PHARMACEUTICAL DIVISION (ISF)

Inoxpa has a specialized division in the manufacturing of components for the pharmaceutical industry. The team of professionals is experienced in the sector and is prepared to comply with the strictest requirements of the pharmaceutical industry. The ISF facilities are specially designed to manufacture this kind of equipment and components. The factory has the corresponding control and test equipment at its disposal.



Agitador magnético: solución altamente higiénica para la dispersión, disolución, homogeneización y mezcla de productos.

Magnetic agitator: a highly hygienic solution for the applications of dispersion, dissolution, homogenization and mixing of products.



PHARMIX. Preparación de productos farmacéuticos estériles. El elemento principal es un agitador magnético.

PHARMIX. Preparation of sterile pharmaceutical products. The main element is a magnetic agitator.



Bomba lobular HLR.
Lobe rotor pump HLR.



Bomba centrífuga Din-Food.
Din-Food centrifugal pump.



Válvulas de diafragma. Pharmaválve.
Diaphragm valve. Pharmaválve.



Válvulas de diafragma. Veevalv.
Diaphragm valve. Veevalv.



Válvulas de diafragma NDL.
NDL diaphragm valve.



Sistema de limpieza CIP.
CIP system.



Reactores para preparación de soluciones inyectables. Incluye instrumentación, agitador, cuadro eléctrico y de control y videoregistrador.

Reactors for preparation of solutions for injections. Includes: instrumentation, agitator, control panel and video recorder.



MCR. Equipo de mezcla con agitador contra-rotación y mixer. Preparación de productos de alta viscosidad a temperatura y presión controlados.

MCR. Skid with counter-rotating agitator and mixer. Preparation of highly viscous products at a controlled temperature and pressure.



Mezclador sólido-líquido M-226.
M-226 Solid/liquid blender.

CR. Agitador contra-rotación.
CR. Counter-rotating agitator.



Agitador aséptico con hélices marina.
Aseptic agitator with marine propeller.



Mixer de alto cizallamiento, fondo de tanque.
Tank bottom high shear mixer.



Mixer de alto cizallamiento multidientes.
High shear "multitooth" mixer.



Mixer de alto cizallamiento En-Línea.
Inline high shear mixer.



Válvulas multivía NEW.
Seat valve.



Válvula de regulación NLR.
NLR regulating valve.



Válvula de retención.
Check valve.



Válvula de alivio.
Overflow valve.



Filtros y mirillas.
Filters and sight-glasses.



Juntas para uso farmacéutico. Certificadas FDA y USP. Clase VI-XXII.
Pharmaceutical gaskets. FDA and USP certified. Class VI-XXII certification.



Grifos tomamuestras asepticos, bolas de limpieza y manómetros.
Aseptic sampling valves, spray balls and pressure gauges.



Sistema de dilución de Lauril Éter Sulfato Sódico (LESS) al 26% para preparación de champús, geles y jabones.
Dilution system of Sodium Laureth Sulfate (SLES) to 26% for preparation of shampoos, gels and soaps.



Fermentador.
Fermenter.



Mezclador Tipo Bicónico MBC. Equipo para la realización de mezcla homogénea de sólidos.
Double Cone Solids Blender MBC. Skid designed to produce homogeneous solid-solid mixture.



Mezclador horizontal de mesa. Horizontal blender.

INOXPA SOLUTIONS



Sistema de distribución. Manifold
Distribution system. Manifold

Sistema de mezcla sólido-líquido automatizado
Automated solid-liquid mixing system



MCR.
Equipo de mezcla con agitador contra-rotación y mixer. Preparación de productos de alta viscosidad a temperatura y presión controlados.
MCR.
Skid with counter-rotating agitator and mixer. Preparation of highly viscous products at a controlled temperature and pressure.



Pasteurizador para la industria alimentaria: zumo, leche, nata, yogur,....
Pasteuriser for the food-processing industry: juice, milk, cream, yogurt, etc.



Automatización: PLC, paneles de control
Automation: PLC, control panels, etc.



Sistema de limpieza CIP
CIP system



INOXPA SA
Telers, 54 – PO Box 174 – 17820
BANYOLES (Girona – Spain)
Tel. +34 972 57 52 00
Fax +34 972 57 55 02
GSM +34 667 16 85 20
inoxpa@inoxpa.com

www.inoxpa.com

DELEGACIÓN NORDESTE
BARCELONA
Tel. +34 937 297 280
inoxpa.nordeste@inoxpa.com

DELEGACIÓN CENTRO
MADRID
Tel. +34 918 716 084
inoxpa.centro@inoxpa.com

DELEGACIÓN LEVANTE
VALENCIA
Tel. +34 963 170 101
inoxpa.levante@inoxpa.com

DELEGACIÓN SUR
CADIZ
Tel. +34 956 140 193
inoxpa.lsur@inoxpa.com

SUMINISTROS TÉCNICOS
ALIMENTARIOS, S.L.
VIZCAYA
Tel. +34 944 572 058
sta@inoxpa.com

DELEGACIÓN VALLADOLID
Tel. +34 983 403 197
sta.valladolid@inoxpa.com

DELEGACIÓN GALICIA,
ASTURIAS Y LEÓN
Tel. +34 638 334 359
sta@inoxpa.com

INOXPA SOLUTIONS FRANCE, SARL
LYON
Tel. +33 474627100
inoxpa.fr@inoxpa.com

PARIS
Tel. +33 130289100
isf@inoxpa.com

S.T.A. PORTUGUESA LDA
ALGERIZ
Tel. +351 256472722
comercial.pt@inoxpa.com

IMPROVED SOLUTIONS
PORTUGAL LDA
VALE DE CAMBRA
Tel. +351 256 472 138
isp.pt@inoxpa.com

INOXPA SKANDINAVIEN A/S
DENMARK
Tel. +45 76286900
inoxpa.dk@inoxpa.com

INOXPA ITALIA, S.R.L.
VENEZIA
Tel. +39 041 - 411236
inoxpa.it@inoxpa.com

INOXPA UK LTD
KENT
Tel. 01737 378060
inoxpa-uk@inoxpa.com

INOXRUS
SAINT PETERSBURG
Tel. +7 812 622 16 26
spb@inoxpa.com

MOSCOW
Tel. Fax +7 495 6606020
moscow@inoxpa.com

INOXRUS UKRAINE
KIEV
Tel. +38044 536 09 57
kiev@inoxpa.com

INOXPA COLOMBIA SAS
BOGOTÁ
Tel. 57-1-7427577
inoxpa.colombia@inoxpa.com

INOXPA USA, INC
CALIFORNIA
Tel. +1 707 585 3900
inoxpa.us@inoxpa.com

INOXPA AUSTRALIA PTY LTD
MORNINGTON
Tel. +61 (3) 5976 8881
inoxpa.au@inoxpa.com

INOXPA SOUTH AFRICA
GAUTENG
Tel. +27 (0)11 794-5223
sales@inoxpa.com

INOXPA ALGERIE S.A.R.L.
ALGER
Tel. +213 (0) 23 83 02 57
inoxpalgerie@inoxpa.com

INOXPA SPECIAL PROCESSING
EQUIPMENT (JIAXING), CO., LTD.
JIAXING, CHINA
Tel. 00 86 573 83570035
inoxpa.cn@inoxpa.com

INOXPA INDIA PRIVATE LIMITED
MAHARASHTRA
Tel. +91 020-64705492
inoxpa.in@inoxpa.com

INOXPA MIDDLE EAST
DUBAI, UAE
Tel. +971 (0)4 372 4408
sales.ae@inoxpa.com



SECTOR ALIMENTARIO
FOOD SECTOR



“Mi compromiso personal y el de todo el equipo de INOXPA es ofrecer el mejor servicio posible y las soluciones más ajustadas a las necesidades de los clientes”.
Candi Granés, General Manager.

FABRICANTES CON ESPÍRITU DE SERVICIO

En INOXPA tenemos claro, que todos los elementos y en general todo lo que signifique desarrollo tecnológico, no es sino un medio para ofrecer el mejor servicio a nuestros clientes. Partimos del concepto compromiso: usted desea una tecnología útil y eficaz que le resuelva sus necesidades con garantía y seguridad, y este es nuestro reto. Partimos de excelentes materias primas, acabados y sistemas homologados y certificados con tecnologías probadas, dignas de la mayor de las solvencias. Nuestro horizonte sigue siendo ofrecer soluciones a través del servicio y la adaptación de cada producto al proceso productivo de nuestros clientes. Esta voluntad de adaptación y servicio la hallará detrás de una marca que aspira a ser un socio sólido y fiable para su empresa.

CALIDAD CERTIFICADA

Consecuentes con nuestra voluntad de objetivar la calidad al máximo nivel, INOXPA está trabajando según los estándares exigidos para cada producto con las normativas de certificación ISO 9001, CE, EHEDG, FDA, ATEX.



“My personal commitment and that of the entire INOXPA team is to offer the finest possible service and the solutions best suited to your needs”.
Candi Granés, General Manager.

MANUFACTURERS WITH A SPIRIT OF SERVICE

We at INOXPA are convinced that all our products and everything involved in the technological development in general is simply means towards offering our clients the finest service. We start out from a concept of commitment: you want useful and effective technology which securely guarantees that your needs are resolved, and that is our challenge. We take as our starting point excellent raw materials with officially approved and certified finishes and systems and proven technologies worthy of the utmost confidence. Our horizon remains that of continuing to offer solutions through service and by adapting each product to our clients' productive processes. You will find this determination to adapt and provide service behind a trademark that aspires to be a firm and reliable partner of your company.

CERTIFIED QUALITY

In pursuance of our will to raise the quality to the highest level, INOXPA is working in compliance with the exigent standards for every product and the certification normatives of ISO 9001, CE, EHEDG, FDA, ATEX.



BOMBAS CENTRÍFUGAS CENTRIFUGAL PUMPS



Hyginox SE



Hyginox SEN



Estampinox EFI



Proloc HCP



DIN-FOOD MR

DIN FOOD/DIN TEX



BOMBAS AUTOASPIRANTES SELF-PRIMING PUMPS



Proloc HCP-SP



Aspir

BOMBA DE RODETE HELICOIDAL HELICOIDAL IMPELLER PUMP



RV



Sistema PIG
Pigging System



Intercambiador
de calor de placas
Plate heat exchanger



ME-1100
Mixers Vertical
Vertical Mixer

ME-6100
Mixer de fondo
Bottom Mixer



ME-4100
Mixer en línea
In-Line Mixer



ME-8100X
Multidentes
Multitooth mixer



MIXERS DE ALTO CIZALLAMIENTO HIGH SHEAR MIXERS

MEZCLADOR SÓLIDO-LÍQUIDO SOLID-LIQUID BLENDER



Horizontal



Gama M
M series



Accesorios
Fittings

Racord:
DIN, SMS, MACON...
Unions:
DIN, SMS, MACON, etc.



Colectores y piezas especiales
Collectors and customized pieces



Paneles de desvío
Flow transfer panels



Filtro recto, escuadra y recto corto.
Straight, angular and dirt trap filters.



Grifos
Sample cocks



Bolas de limpieza
Spray balls



Mirillas: plana y tubular
Sight glasses:
flat and tubular



Válvula de retención y presión-vacío
Check valve and pressure/vacuum
vent valve

BOMBAS LOBULARES ROTATIVAS LOBE ROTOR PUMPS



SLR con bancada
SLR with baseplate



SLR

HLR



TLS

BOMBAS DE RODETE FLEXIBLE FLEXIBLE IMPELLER PUMPS



RF-EL

RF



Kiber KST

Kiber KSF

Kiber KS

BOMBAS DE TORNILLO HELICOIDAL PROGRESSIVE CAVITY PUMPS

Kiber KVB

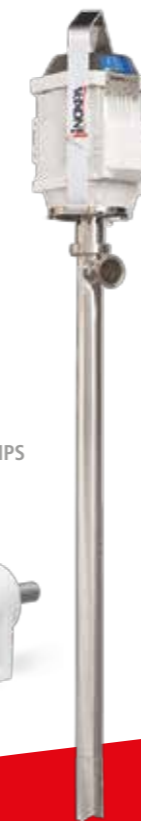

CR.
Agitador contra-rotación.
CR.
Counter-rotating agitator.

AGITADORES AGITATORS



AGC con áncora
AGC with anchor

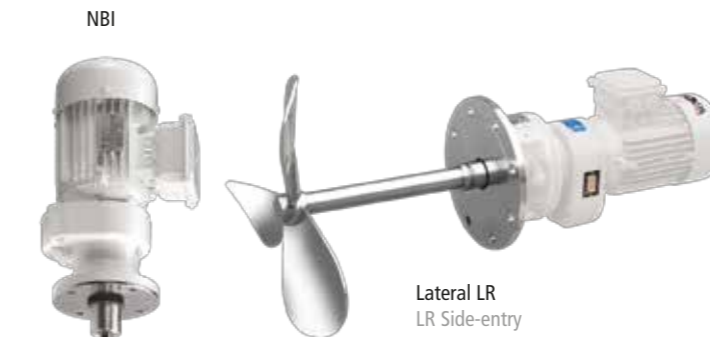

Lateral LR
LR Side-entry

4 palas inclinadas
4 inclined blades

Hélice Cowler
Saw tooth propeller



Válvulas de mariposa
y de bola, manuales
o neumáticas
Butterfly and ball valves,
manually or pneumatically
actuated.



Válvula de doble mariposa
Double butterfly valve



Válvulas de diafragma. Veevalv
Diaphragm valve. Veevalv



VALVULAS MULTIVÍA SEAT VALVES



NLM



NLF



NLR



Válvulas de alivio
Overflow valves

El origen The Origin L'origine Исходный пункт



Oficina técnica Technical office Bureau d'études Технический отдел

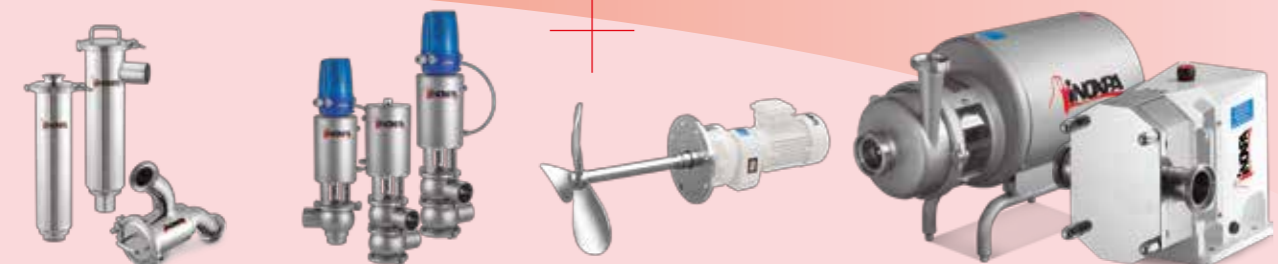

Accesorios, válvulas y bombas Fittings, valves and pumps
Accessoires, vannes et pompes Соединительная арматура, клапаны и насосы

Ingeniería Engineering Ingégnierie Разработка и конструирование

Equipos estructurados. Soluciones
Structured skids. Solutions.



Skids standardisés. Solutions
Структурированное оборудование. Решения



Instalaciones. Líneas de producción Installations. Production lines
Installations. Lignes de production Установки. Производственные линии

Know how
Know how
Savoir faire
Ной-хэй

Source of solutions



Proyecto llave en mano Turn-key project
Projet clé en main Проект "под ключ"

Ingeniería obra civil
Civil engineering
Ingénierie génie civile
Строительная инженерия



INOXPA SA
Telers, 54 – PO Box 174 – 17820
BANYOLES (Girona – Spain)
Tél. +34 972 57 52 00
Fax +34 972 57 55 02
GSM +34 667 16 85 20
inoxpa@inoxpa.com

www.inoxpa.com

DELEGACIÓN NORDESTE
BARCELONA
Tel. +34 937 297 280
inoxpa.nordeste@inoxpa.com

DELEGACIÓN CENTRO
MADRID
Tel. +34 918 716 084
inoxpa.centro@inoxpa.com

DELEGACIÓN LEVANTE
VALENCIA
Tel. +34 963 170 101
inoxpa.levante@inoxpa.com

DELEGACIÓN SUR
CADIZ
Tel. +34 956 140 193
inoxpa.lsur@inoxpa.com

SUMINISTROS TÉCNICOS
ALIMENTARIOS, S.L.
VIZCAYA
Tel. +34 944 572 058
sta@inoxpa.com

DELEGACIÓN VALLADOLID
Tel. +34 983 403 197
sta.valladolid@inoxpa.com

DELEGACIÓN GALICIA,
ASTURIAS Y LEÓN
Tel. +34 638 334 359
sta@inoxpa.com

INOXPA SOLUTIONS FRANCE, SARL
LYON
Tel. +33 474627100
inoxpa.fr@inoxpa.com

PARIS
Tel. +33 130289100
isf@inoxpa.com

S.T.A. PORTUGUESA LDA
ALGERIZ
Tel. +351 256472722
comercial.pt@inoxpa.com

IMPROVED SOLUTIONS
PORTUGAL LDA
VALE DE CAMBRA
Tel. +351 256 472 138
isp.pt@inoxpa.com

INOXPA SKANDINAVIEN A/S
DENMARK
Tel. +45 76286900
inoxpa.dk@inoxpa.com

INOXPA ITALIA, S.R.L.
VENEZIA
Tel. +39 041 - 411236
inoxpa.it@inoxpa.com

INOXPA UK LTD
KENT
Tel. 01737 378060
inoxpa-uk@inoxpa.com

INOXRUS
SAINT PETERSBURG
Tel. +7 812 622 16 26
spb@inoxpa.com

MOSCOW
Tel. +7 495 6606020
moscow@inoxpa.com

INOXRUS UKRAINE
KIEV
Tel. +38044 536 09 57
kiev@inoxpa.com

INOXPA COLOMBIA SAS
BOGOTÁ
Tel. 57-1-7427577
inoxpa.colombia@inoxpa.com

INOXPA USA, INC
CALIFORNIA
Tel. +1 707 585 3900
inoxpa.us@inoxpa.com

INOXPA AUSTRALIA PTY LTD
MORNINGTON
Tel. +61 (3) 5976 8881
inoxpa.au@inoxpa.com

INOXPA SOUTH AFRICA
GAUTENG
Tel. +27 (0)11 794-5223
sales@inoxpa.com

INOXPA ALGERIE S.A.R.L.
ALGER
Tel. +213 (0) 23 83 02 57
inoxpalgerie@inoxpa.com

INOXPA SPECIAL PROCESSING
EQUIPMENT (JIAXING), CO., LTD.
JIAXING, CHINA
Tel. 00 86 573 83570035
inoxpa.cn@inoxpa.com

INOXPA INDIA PRIVATE LIMITED
MAHARASHTRA
Tel. +91 020-64705492
inoxpa.in@inoxpa.com

INOXPA MIDDLE EAST
DUBAI, UAE
Tel. +971 (0)4 372 4408
sales.ae@inoxpa.com

C.DAIRY.ES/EN/FR/RUS.0615



IDS INOXPA DAIRY SOLUTIONS

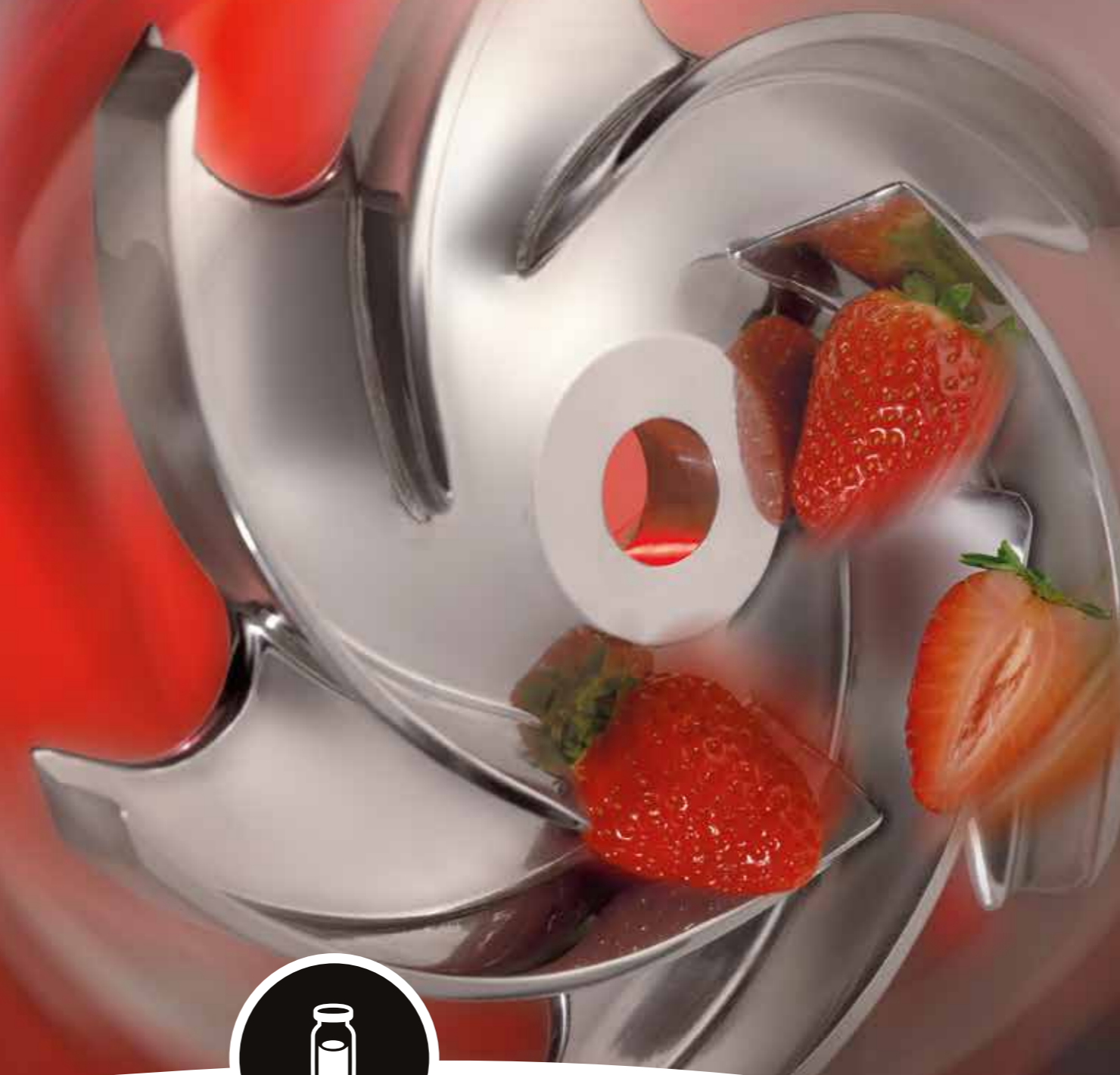

"Mi compromiso personal y el de todo el equipo de INOXPA es ofrecer el mejor servicio posible y las soluciones más ajustadas a las necesidades de los clientes".
Candi Granés, General Manager.

EXPERTOS EN SOLUCIONES LÁCTEAS

INOXPA, empresa fundada en el año 1972, con sede en Banyoles, España, con delegaciones propias en varios países y con una red de más de 100 puntos de distribución en los 5 continentes, ofrece a sus clientes una gran experiencia en la fabricación de equipos y componentes de calidad para el sector alimentario, y específicamente para la industria láctea.

Con la finalidad de diseñar y desarrollar proyectos integrales adaptados a sus necesidades nace INOXPA DAIRY SOLUTIONS, una nueva división destinada a aportar soluciones en todas las fases de su proyecto.

INSTALACIONES LLAVE EN MANO

Desde la concepción hasta la puesta en marcha de las líneas de producción en sus instalaciones, nuestros expertos equipos de profesionales le ofrecerán las máximas garantías durante todo el proceso de fabricación y instalación.

"My personal commitment and that of the entire INOXPA team is to offer the finest possible service and the solutions best suited to your needs".
Candi Granés, General Manager.

EXPERTS IN DAIRY SOLUTIONS

The INOXPA company was founded in 1972 and has its headquarters in Banyoles, Spain, as well as own branches based in many different countries plus a network of more than 100 distribution points over 5 continents. INOXPA offers its clients a wide experience in the manufacture of quality equipment and components for the food sector, and in particular the dairy industry.

With the aim in mind to design and develop complete projects according to your needs, INOXPA DAIRY SOLUTIONS was conceived, a new division destined to provide solutions for all phases of your project.

'TURNKEY' INSTALLATIONS

From conception until the start-up of the production lines in your plant or factory, our expert team of professionals offers you the maximum guarantees throughout the entire fabrication and installation processes.

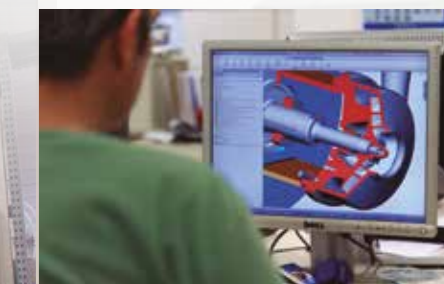

INOXPA DAIRY SOLUTIONS le ofrece la instalación o servicio más adecuado para cada caso; desde una válvula, un equipo o un skid, hasta el diseño integral de la planta más completa con un alto grado de automatización. Nuestra filosofía se basa en el servicio y en el acompañamiento, por eso siempre completamos nuestros productos con servicios de ingeniería y know how. INOXPA DAIRY SOLUTIONS, su proveedor de confianza para cualquier tipo de solución a medida para la industria láctea.

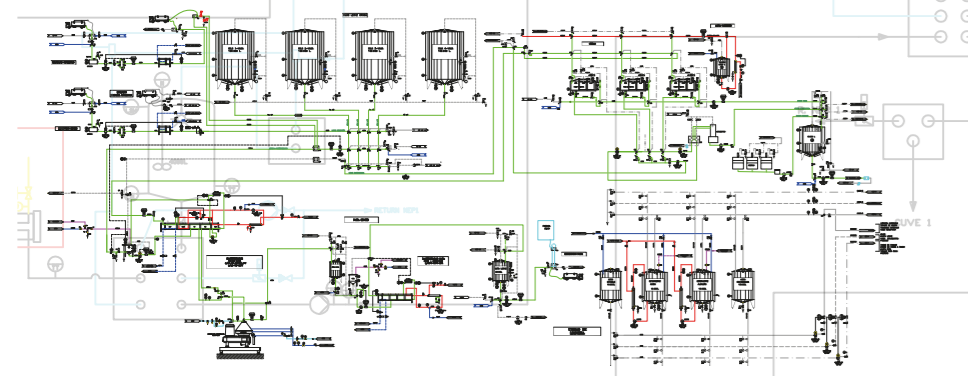

INOXPA DAIRY SOLUTIONS offers you the most adequate product, installation or service for every necessity; from a valve, equipment or a skid, up to the complete design of a full-scale plant incorporating advanced levels of automation. Our philosophy is based on service and presence alongside the customer which is why we always complete our projects with comprehensive engineering services and know-how. INOXPA DAIRY SOLUTIONS, your reliable supplier for any type of made to measure solution for the dairy industry.

INOXPA DAIRY SOLUTIONS vous propose les produits, installations ou services les mieux adaptés à chacun de vos besoins; une vanne, un skid, un ensemble, et cela jusqu'à la conception intégrale de l'unité ainsi que son automatisation. Notre philosophie est basée sur le service et l'accompagnement, c'est pour cela que nous complétons tous nos produits avec des services d'ingénierie et de savoir-faire. INOXPA DAIRY SOLUTIONS, votre fournisseur de confiance pour n'importe quel type de solutions sur mesure pour l'industrie du lait.

INOXPA DAIRY SOLUTIONS предлагает компоненты, установки и услуги, наиболее подходящие для каждого конкретного случая, начиная с клапанов и установок и вплоть до разработки полностью укомплектованной линии с высокой степенью автоматизации. Наша философия основывается на сервисе и близости к клиенту, поэтому мы всегда дополняем нашу продукцию инженерной поддержкой и ноу-хау. INOXPA DAIRY SOLUTIONS, Ваш надежный поставщик индивидуальных решений для молочной промышленности.

Yogurt
Yoghurt, sour-cream
Yaourt, l'ben
Кефир, сметана



Proceso de automatización
Automation process
Procédé d'automatisation
Автоматизированный процесс



Proceso de limpieza CIP
CIP Cleaning process
Process de nettoyage CIP
Процесс мойки CIP

Leche líquida
Liquid milk



Lait liquide
Жидкое молоко



Recepción. Estoc
Reception. Stock
Réception stockage
Приёмка молока

Postres lácteos
Dairy desserts
Desserts lactés
Молочные десерты



IDS INOXPA SOLUCIONES LÁCTEAS
INOXPA DAIRY SOLUTIONS
INOXPA SOLUTIONS LACTEES
INOXPA ОБОРУДОВАНИЕ ДЛЯ
МОЛОЧНОЙ ПРОМЫШЛЕННОСТИ



Queso
Cheese
Fromage
Сыр

Suero.
Leche concentrada
Whey.
Concentrated milk



Sérum.
Lait concentré
Сыворотка.
Концентрированное молоко

Componentes Components Composants Компоненты



Bombas centrifugas: Hyginox, Prolac
Centrifugal pumps: Hyginox, Prolac
Pompes centrifuges: Hyginox, Prolac
Центробежные насосы: Hyginox, Prolac



Bomba lobular rotativa: SLR
Lobe rotor pump: SLR
Pompes a lobes: SLR
Кулачковый насос: SLR



Bomba de rodete helicoidal: RV
Helicoidal impeller pump: RV
Pompes helico-centrifuges: RV
Насос с геликоидальным ротором: RV



Sistema PIG
Pigging product recovery system
Système de raclage PIG
Система безразборной очистки PIG

Bomba de tornillo helicoidal: Kiber
Progressive cavity pump: Kiber
Pompes a rotor excentré: Kiber
Винтовой насос: Kiber



Mezclador sólido-líquido
Solid-liquid blender
Melangeur poudre/liquide
Блендер порошок/жидкость



Intercambiador de calor de placas
Plate heat exchanger
Echangeur thermique à plaques
Пластинчатый теплообменник



AGC con áncora
AGC agitator with anchor
AGC à ancre
Якорная мешалка AGC



Agitador lateral LR
LR side-entry agitator
Agitateur latéral LR
Боковая мешалка LR



Paneles de desvío
Flow transfer panels
Tableau de pontage
Панели переключения потоков



Válvulas de mariposa manuales o neumáticas
Manually or pneumatically actuated butterfly valves
Vannes papillon manuelles et pneumatiques.
Дисковые затворы с ручным или пневматическим приводом



Válvula de doble mariposa
Double butterfly valve
Vanne double papillon
Двойной дисковый затвор



Válvulas multivia
Seat Valves
Vannes a clapet
Седельные клапаны



Filtros
Filters
Filtres
Фильтры